







27 412 845



- spout: circular, air-enriched flow
- max. flow 16.9 l/min at 3 bar flow pressure
- Hand shower: COMPACT RAIN, max. flow rate 6.8 l/min (at 3 bar)
- complete hand shower set with anti-scale system
- 200mm projection
- automatic bath/shower diverter
- height of mixer 141 mm
- height up to aerator 88 mm
- hole diameter spout 32 mm
- hole diameter single-lever mixer 35 mm
- hole diameter for complete hand shower set 32 mm
- rosette for complete hand shower set Ø 50mm
- metal shower hose 1750mm with integrated anti-twist protection

Note: Local building codes may require the use of an anti-scald device. Please refer to remote pressure balance valve (35 910 970 90)

Intrinsic protection against back flow.

	Chrome	27 412 845-00
	Brushed Platinum	27 412 845-06
	Dark Chrome	27 412 845-19
	Matte Black	27 412 845-33
	Brushed Chrome	27 412 845-93
	Brushed Dark Platinum	27 412 845-99





LISSÉ Three-hole single-lever bath mixer for bath rim or tile edge installation -  
Chrome

---

LISSÉ

27 412 845

Certificates

---

IAPMO\_4976 (5). Belgaqua\_19\_80\_27. LGA\_29731.

Belgaqua\_24-008-  
27\_4.

27 412 845

Parts for other  
finishes can be found  
here: Brushed  
Platinum

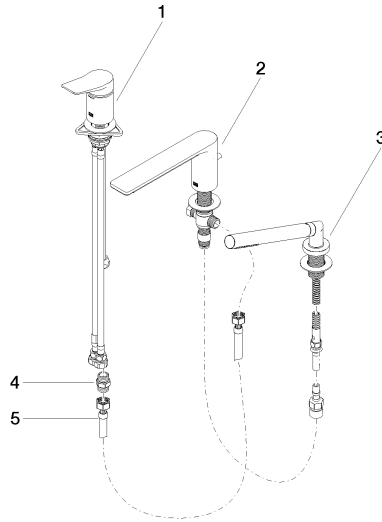

**Spare parts list**

No.	Item Number	Name	Quantity used	Delivery time
1	29 300 845-00	connection	1	60
2	13 512 845-00	spout	1	60
3	27 702 979-00	Hand shower set for bath rim or tile edge installation - Chrome	1	10
4	90 24 03 168 00 90	nipple	1	2
5	12 502 970 90	High pressure hose 1/2" x 1/2" x 400 mm -	1	2